

## PRODUCT INTRODUCTION

OD50 pendant luminaires have a wide light distribution, with different heights and various housing colors, making them ideal not just for uniform general lighting. By selecting the high-quality LEDs, it offers the designer the best light quality with excellent color rendering. Such directed light creates a fascinating and cozy atmosphere.

## SPECIFICATION

Wattage : 15W / 18W  
 Color temperature : 2700K / 3000K / 4000K  
 Housing Length: 200mm / 255mm  
 310mm / 365mm  
 CRI : Ra97 / Ra90 / Ra80  
 Beam angle : 18° / 24° / 36°  
 Input voltage : AC220V-240V  
 Dimming : 0/1-10V , DALI , TRIAC , CASAMBI

## FEATURES

Product surface color : White, Black, Customized  
 Mounting: Surface-mounted  
 Protection degree : IP20 (En60598)  
 Energy efficiency: EELCD



## Radial distribution & Conical illuminance

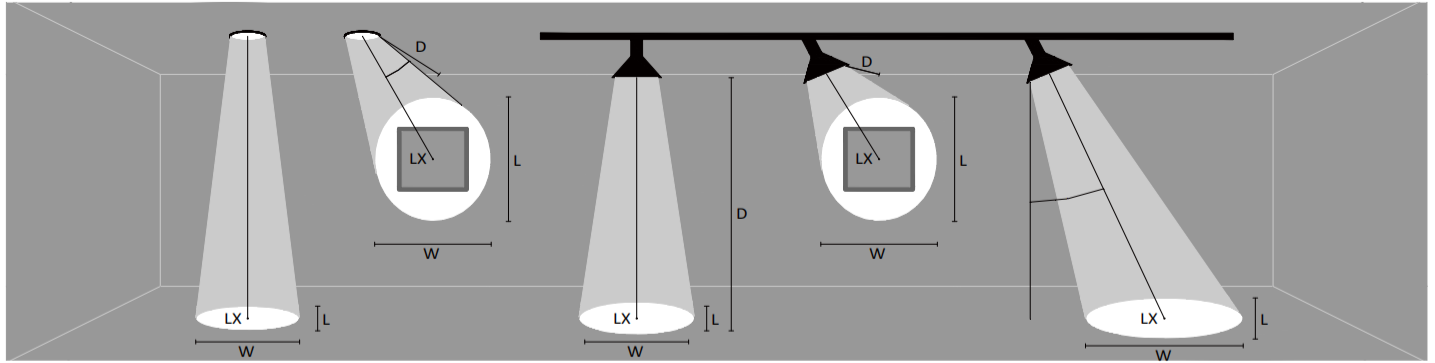

D Distance To Fix From Wall or Floor

LX Initial illuminance Level At Center of Beam

L Beam Length (where candlepower drops to 50% of maximum)

W Beam Width (where candlepower drops to 50% of maximum)

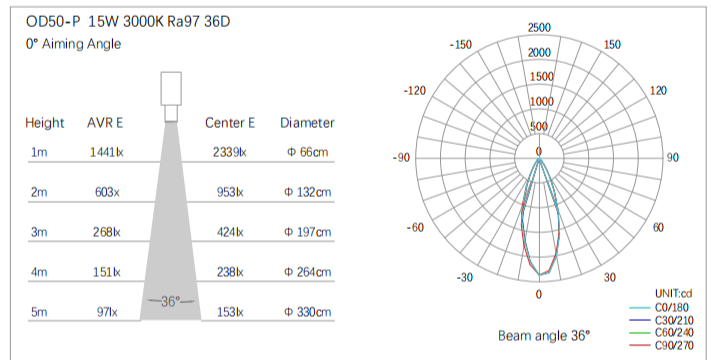
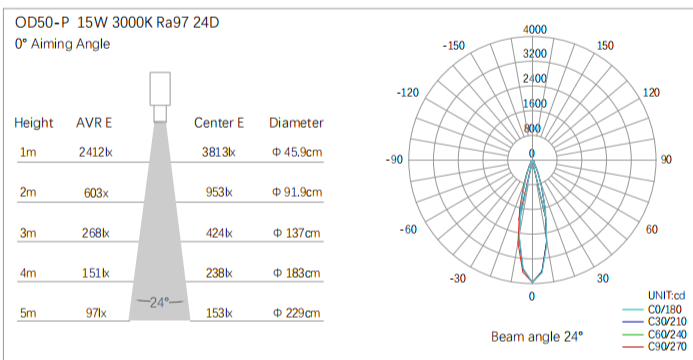

## Lighting effect

### Lighting distribution

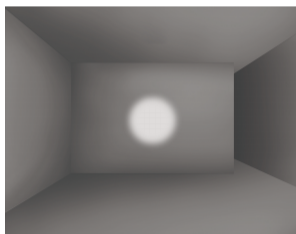

18°

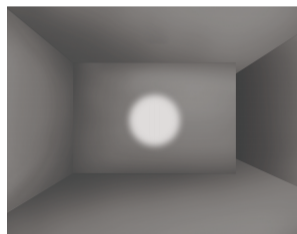

24°

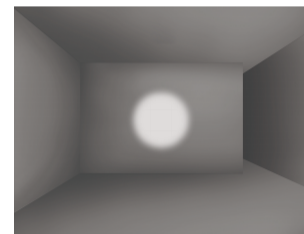

36°

### Lighting distribution

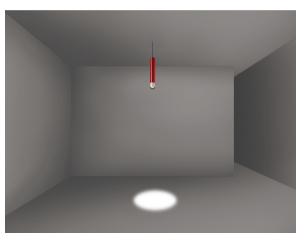

## Specifications

Model No.	Total Power (W)	LED Power (W)	Voltage	CRI (Ra)	Color Temp (K)	Luminous Flux (lm)	Beam Angle	IP Grade
OD50-P	15	13.5	AC220V-240V	90	2700	1150	18° / 24° / 36°	IP20
					3000	1211		
					4000	1275		
OD50-P	18	16.2			2700	1380		
					3000	1453		
					4000	1530		

· Thermally stable typical lumens (±10%)

## Package information

Model No.	Packaging/Unit	Pieces/Unit	Dimensions (L x W x H)	Gross Weight	Volume
OD50-P 255mm	Inner box	1	80x80x300mm	0.64kg	1.92dm <sup>3</sup>
	Outer box	20	450x350x330mm	15.8kg	51.97dm <sup>3</sup>
OD50-P 310mm	Inner box	1	80x80x355mm	0.71kg	2.27dm <sup>3</sup>
	Outer box	20	450x350x390mm	17.1kg	61.42dm <sup>3</sup>